



CBK SERIES

(P.N. 8509, Revision A7, August 2007)

Software Rev.: 4.28 & above
4.25H & above for CBK 8H/16aH

CONTENTS

1.0	INTRODUCTION.....	2
2.0	SPECIFICATIONS.....	3
3.0	INSTALLATION.....	4
3.1	UNPACKING.....	4
3.2	LOCATING	5
3.2	SETTING UP	6
4.0	KEYPAD.....	7
5.0	DISPLAY	8
6.0	SYMBOLS AND INDICATORS	8
7.0	BATTERY.....	9
8.0	BACKLIGHT	9
9.0	AUTO POWER OFF.....	9
10.0	OPERATIONS.....	10
10.1	ZEROING.....	10
10.2	TARING	10
10.2.1	Manual tare.....	10
10.2.2	Preset Tare	11
10.3	WEIGHING	11
10.4	PARTS COUNTING.....	11
10.5	CHECK-WEIGHING	13
10.5.1	Setting up check-weighing while weighing.....	14
10.5.2	Setting up check-weighing while parts counting or % weighing.....	14
10.6	LIMITS STORING AND RECALLING.....	15
10.7	PERCENT WEIGHING	16
10.8	ACCUMULATED TOTAL.....	17
10.8.1	Manual Accumulation	18
10.8.2	Automatic Accumulation	19
11.0	RS-232 INTERFACE	20
11.1	INPUT COMMANDS FORMAT.....	22
12.0	CALIBRATION	23
13.0	PARAMETER SETTINGS	24
13.1	CHECK WEIGHING PARAMETERS.....	24
13.2	RS-232 PARAMETERS.....	26
13.3	SCALE PARAMETERS	27
14.0	ERROR MESSAGES	29
15.0	REPLACEMENT PARTS AND ACCESSORIES	30
16.0	SERVICE INFORMATION.....	30
17.0	WARRANTY INFORMATION.....	31
18.0	APPENDIX	32

1.0 INTRODUCTION

- The **CBK** range of scales provides an accurate, fast and versatile general purpose weighing scales with parts counting, percent weighing and check-weighing functions.
- There are two series within the range. The **CBKa** series are similar to the **CBK** series except the **CBKa** scales can operate in both imperial and metric weighing units, whereas for the **CBK** series the imperial units are not available.
- All models have LEDs to indicate when a weight is below the low limit, between the limits or above the high limit next to the display. These can work in conjunction with an audible alarm for check weighing as well as LCD showing LO, OK and HI.
- All scales have stainless steel weighing platforms on an ABS base assembly.
- They are supplied with a RS-232 bi-directional interface and real time clock (RTC).
- The scales have sealed keypads with colour coded membrane switches and a large easy to read liquid crystal type display (LCD) supplied with a backlight.
- They include automatic zero tracking, semi-automatic & pre-set tare, accumulation facility that allows the weight to be stored and recalled as an accumulated total.

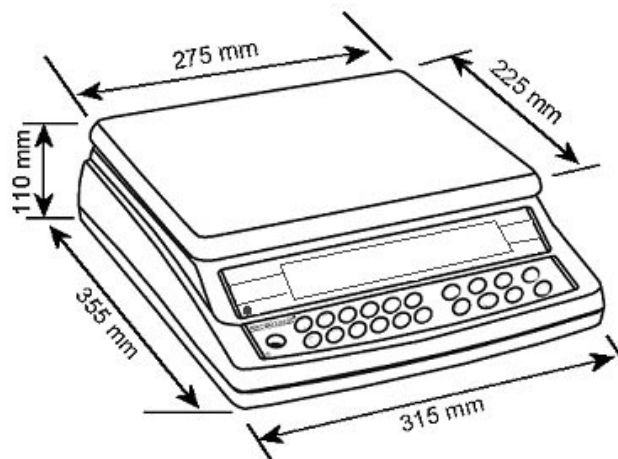

2.0 SPECIFICATIONS

	CBK 4	CBK 8H	CBK 8	CBK 16	CBK 32	CBK 48
Kilograms						
Maximum Capacity	4 kg	8 kg	8 kg	16 kg	32 kg	48 kg
Tare Range	-4 kg	-8 kg	-8 kg	-9.9995 kg	-32 kg	-48 kg
Readability	0.0001 kg	0.0001 kg	0.0002 kg	0.0005 kg	0.001 kg	0.002 kg
Repeatability (S.D.)	0.0001 kg	0.0001 kg	0.0002 kg	0.0005 kg	0.001 kg	0.002 kg
Linearity (±)	0.0002 kg	0.0002 kg	0.0004 kg	0.001 kg	0.002 kg	0.004 kg
Grams						
Maximum Capacity	4000 g	8000 g	8000 g	16000 g	32000 g	48000 g
Tare Range	-4000 g	-8000 g	-8000 g	-9999.5 g	-32000 g	-48000 g
Readability	0.1 g	0.1 g	0.2 g	0.5 g	1 g	2 g
Repeatability (S.D.)	0.1 g	0.1 g	0.2 g	0.5 g	1 g	2 g
Linearity (±)	0.2 g	0.2 g	0.4 g	1 g	2 g	4 g

CBKa Series (USA models)

	CBK 8a	CBK 16aH	CBK 16a	CBK 35a	CBK 70a	CBK 100a
Pounds						
Maximum Capacity	8 lb	16 lb	16 lb	35 lb	70 lb	100 lb
Tare Range	-8 lb	-9.9995 lb	-9.9995 lb	-35 lb	-70 lb	-99.995 lb
Readability	0.0002 lb	0.0002 lb	0.0005 lb	0.001 lb	0.002 lb	0.005 lb
Repeatability (S.D.)	0.0002 lb	0.0002 lb	0.0005 lb	0.001 lb	0.002 lb	0.005 lb
Linearity (±)	0.0004 lb	0.0004 lb	0.001 lb	0.002 lb	0.004 lb	0.01 lb
Ounces						
Maximum Capacity	128 oz	256 oz	256 oz	560 oz	1120 oz	1600 oz
Readability	0.005 oz	0.005 oz	0.01 oz	0.02 oz	0.05 oz	0.1 oz
Repeatability (S.D.)	0.005 oz	0.005 oz	0.01 oz	0.02 oz	0.05 oz	0.1 oz
Linearity (±)	0.01 oz	0.01 oz	0.02 oz	0.04 oz	0.1 oz	0.2 oz
Pounds:Ounces						
Maximum Capacity	8 lb: 0.0 oz	16 lb: 0.0 oz	16 lb: 0.0 oz	35 lb: 0.0 oz	70 lb: 0.0 oz	99 lb: 15.9 oz
Display shows	8: 16.00	16: 16.0	16: 16.0	35: 16.0	70: 16.0	99: 16.0
Readability	0.01 oz	0.1 oz	0.1 oz	0.1 oz	0.1 oz	0.1 oz
Repeatability (S.D.)	0.01 oz	0.1 oz	0.1 oz	0.1 oz	0.1 oz	0.1 oz
Linearity (±)	0.02 oz	0.2 oz	0.2 oz	0.2 oz	0.2 oz	0.2 oz
Kilograms						
Maximum Capacity	4 kg	8 kg	8 kg	16 kg	32 kg	48 kg
Readability	0.0001 kg	0.0001 kg	0.0002 kg	0.0005 kg	0.001 kg	0.002 kg
Repeatability (S.D.)	0.0001 kg	0.0001 kg	0.0002 kg	0.0005 kg	0.001 kg	0.002 kg
Linearity (±)	0.0002 kg	0.0002 kg	0.0004 kg	0.001 kg	0.002 kg	0.004 kg
Grams						
Maximum Capacity	4000 g	8000 g	8000 g	16000 g	32000 g	48000 g
Readability	0.1 g	0.1 g	0.2 g	0.5 g	1 g	2 g
Repeatability (S.D.)	0.1 g	0.1 g	0.2 g	0.5 g	1 g	2 g
Linearity (±)	0.2 g	0.2 g	0.4 g	1 g	2 g	4 g

OTHER SPECIFICATIONS

Units of measure	CBK Series- kg, g CBKa Series- kg, g, lb, oz, lb:oz
Interface	RS-232 bi-directional Interface
Stabilisation Time	2 Seconds typical
Operating Temperature	-10°C to 40°C 14°F to 104°F
Power supply	230 VAC 50/60 Hz 115 VAC available
Battery	Internal rechargeable battery (~90 hours operation)
Calibration	Automatic External
Display	6 digits LCD digital display with capacity tracker and symbols for units
Scale Housing	ABS Plastic, Stainless Steel platform
Pan Size	225 x 275 mm 8.9" x 10.8"
Overall Dimensions (wxdxh)	315 x 355 x 110 mm 12.4" x 14" x 4.3"
Net Weight	4.1 kg 9 lb
Applications	Weighing Scales
Functions	Weighing, Parts counting, % weighing, Check weighing, Check counting, Accumulation of weights
Date/Time	Real Time Clock (RTC), To print date and time information- battery backed



3.0 INSTALLATION

3.1 UNPACKING

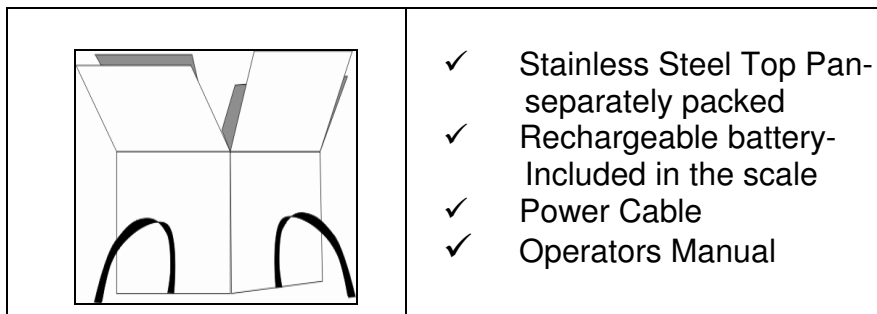
Remove the scale from the packing carefully. Inside the box you will find everything needed to start using the scale-

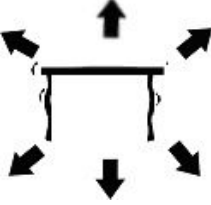
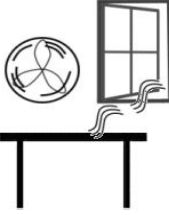

3.2 LOCATING

	<ul style="list-style-type: none">• The scales should not be placed in a location that will reduce the accuracy.• Avoid extremes of temperature. Do not place in direct sunlight or near air conditioning vents.
	<ul style="list-style-type: none">• Avoid unsuitable tables. The table or floor must be rigid and not vibrate.• Avoid unstable power sources. Do not use near large users of electricity such as welding equipment or large motors.
	<ul style="list-style-type: none">• Do not place near vibrating machinery.• Avoid high humidity that might cause condensation. Avoid direct contact with water. Do not spray or immerse the scales in water.
	<ul style="list-style-type: none">• Avoid air movement such as from fans or opening doors. Do not place near open windows or air-conditioning vents.• Keep the scales clean. Do not stack material on the scales when they are not in use.

3.2 SETTING UP

- The CBK Series comes with a stainless steel platform packed separately.
- Place the platform in the locating holes on the top cover.
- **Do not** press with excessive force as this could damage the load cell inside.
- Level the scale by adjusting the four feet. The scale should be adjusted such that the bubble in the spirit level is in the centre of the level and the scale is supported by all four feet.

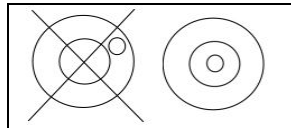

- Attach the power cable to the connector on the base on the left of the scale. Plug in the power cable to the mains. Switch on the power switch located on the base on the right side of the scale.

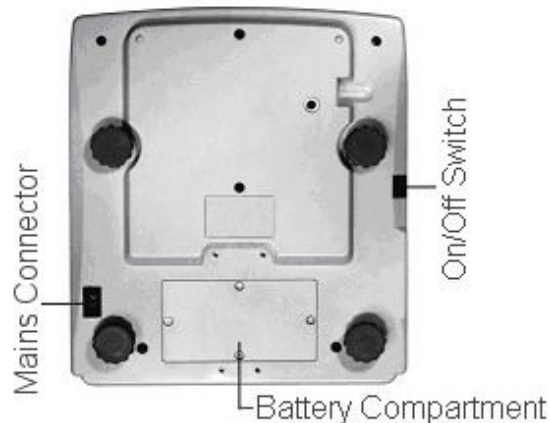

- The scale will first display the software revision then run a self-test. At the end of the self-test it will display zero weight when a stable condition has been achieved. A stable symbol and zero symbol indicators are also displayed.

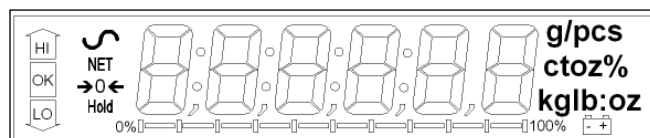

4.0 KEYPAD

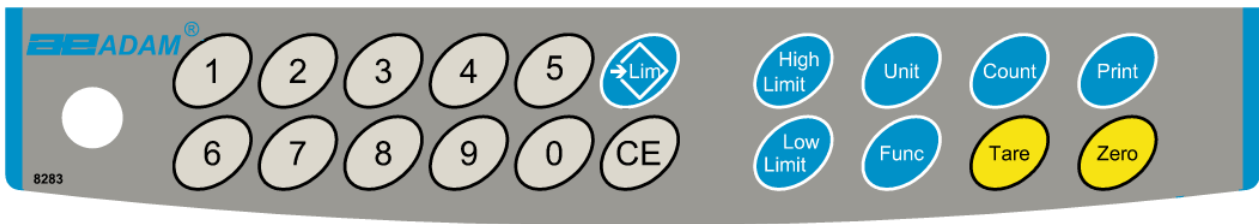

KEYS	PRIMARY FUNCTION	SECONDARY FUNCTION
[Zero]	Sets the zero point for all subsequent weighing. The display shows zero.	Escape from any setting menus
[Tare]	It tares the scale and stores the current weight in memory as a tare value, subtracts the tare value from the weight and shows the results. This is the net weight.	Accept the set values
[Unit]	This is used to select the weighing units from a preset list of available units.	Allows the weight, unit weight, and count to be seen when parts counting or to change from weight to % in percent weighing
[Low Limit] & [High Limit]	It sets the limits for check weighing and allows setting of either the low limit or the high limit or both.	None
[→Lim]	It stores and recalls any of 10 preset limits	None
[Func]	This is used to select percent weighing, RS-232 parameters, Operation of the bar graph, RTC settings, User ID and Scale ID.	None
[Count]	Enter Parts Counting	None
[Print]	It is used to print the results to a PC or printer using the RS-232 interface. It also adds the value to the accumulation memory if the accumulation function is not automatic.	None
[1] to [0] and [CE]	Allow entering numerical values where required, setting of limits, time and date for example.	

5.0 DISPLAY

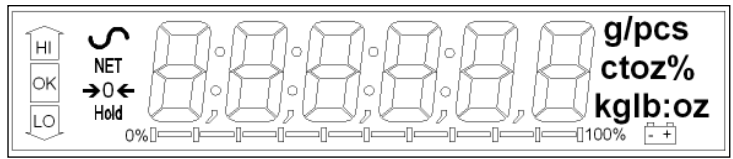

6.0 SYMBOLS AND INDICATORS

The LCD has unique symbols to indicate the following:

→0←	The display is at Zero
S	The scale is Stable
Net	Net weight- The scale has been tared
kg / g / lb / oz / lb:oz	Symbols shown for the units
	Capacity Tracker- A bar graph indicating the proportion of the scale capacity being used by the weight on the pan
bAt LO or	Low battery
%	The scale is in Percent weighing mode
pcs	The scale is in Parts counting mode
HI, OK, LO	The scale is in Check weighing mode
:	The colons “:” are used to separate pounds from ounces and for the real time clock.

Next to the LCD are a number of LED's that show when the weight is below, within or over the limits during check weighing.

Weight	LED	LCD
below the low limit	Amber	LO
Within the limits	Green	OK
Above the high limit	Red	HI

NOTE: The LED's can be set by the user to off, bar or spot mode.
See “**F3 LED**” in section 13.1

7.0 BATTERY

- The scales can be operated from the battery, if desired. The battery life is approximately 90 hours.
- When the battery needs charging a symbol on the display will turn on. The battery should be charged when the symbol is on. The scale will still operate for about 10 hours after which it will automatically switch off to protect the battery.
- To charge the battery, simply plug into the mains power supply. The scale does not need to be turned on.
- The battery should be charged for 12 hours for full capacity.
- To the left of the display is a LED to indicate the status of battery charging. When the scale is plugged into the mains power the internal battery will be charged. If the LED is green the battery is being charged. If it is red it is nearly discharged and yellow indicates the battery is increasing the charge level. Continue to charge overnight for a complete re-charge.

8.0 BACKLIGHT

The backlight for the LCD can be set by the user to always off, always on or automatic (on only when the scale is in use or a key is pressed). See setting of the parameter "**S2 bl**" in section 13.3.

9.0 AUTO POWER OFF

The auto power off can be set by the user to disable the feature or to a pre-set time interval. See setting of the parameter "**S3 Aof**" in section 13.3.

10.0 OPERATIONS

10.1 ZEROING

- You can press the **[Zero]** key at any time to set the zero point from which all other weighing and counting is measured. This will usually be necessary when the platform is empty. When the zero point is obtained the display will show the zero indicator.



- The scale has an automatic re-zeroing function to account for minor drifting or accumulation of material on the platform. However you may need to press **[Zero]** to re-zero the scale if small amount of weight is still shown when the platform is empty.

10.2 TARING

10.2.1 Manual tare

- Zero the scale by pressing **[Zero]**. The zero indicator will be on. Place a container on the pan and its weight will be displayed.
- Press **[Tare]** when the reading is stable. The weight that was displayed is stored as the tare value and it is subtracted from the display, leaving zero on the display. The stable and **Net** indicator will be on.



- As a product is added only the weight of the product will be shown. The scale could be tared a second time if another type of product was to be added to the first one. Again only the weight that is added after taring will be displayed.



NOTE:

When the container is removed a negative value will be shown. If the scale was tared just before removing the container, this value is the gross weight of the container plus all products which were removed. The zero indicator will also be on as the platform is back to the same condition it was when **[Zero]** was pressed last.

Press **[Tare]** or **[Zero]** to remove the tare value and display zero. The Net indicator will disappear.

10.2.2 Preset Tare

When the scale is at zero with no weight on the platform it is possible to enter a preset tare.

- Zero the scale by pressing **[Zero]**. The zero indicator will be on.
- Enter a value using the numeric keys.
- Press **[Tare]** to tare the scale. The value that was entered is stored as the tare value and it is subtracted from the display, leaving a negative number on the display.

10.3 WEIGHING

To determine the weight of a sample, first tare an empty container if used, then place the sample in the container. The display will show the weight and the unit of weight currently in use.



To change the weighing unit press the **[Unit]** key. Weighing units displayed are the ones that are enabled by the user in the parameters section. See section 13.3.

10.4 PARTS COUNTING

The scale can be used to count parts based on the average weight of a sample weighed on the scale. When more parts are added the total number of parts is displayed.

- If a container is to be used, place this container on the platform before entering parts counting and press **[Tare]**.



- Press **[Count]** to enter the Parts Counting mode. The display will show the last sample size used. For example, "10 Pcs".



- Either place 10 parts on the platform for determining the average piece weight or use a different number of parts. For example, place 20 parts on the platform, press **[CE]** to clear the last values and then enter the value 20 using the numeric keypad.



- Press **[Count]** to weigh the samples and determine an average piece weight.
- If the parts are too light to measure accurately, the count may become faulty. It is suggested that the samples to be weighed should each weigh more than the resolution of the scale.
- After the sample has been weighed the scale will count any other parts added by applying the average piece weight to the weight of the parts to be counted.

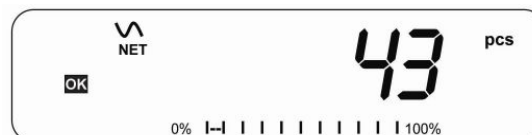

- The **[Tare]** key works normally during this time, so it is possible to tare the display with a container on the platform or to enter a preset tare value as described in section 10.2.2.
- During parts counting the display can be changed to show the net weight, unit weight and number of parts by each time pressing the **[Func]** key.

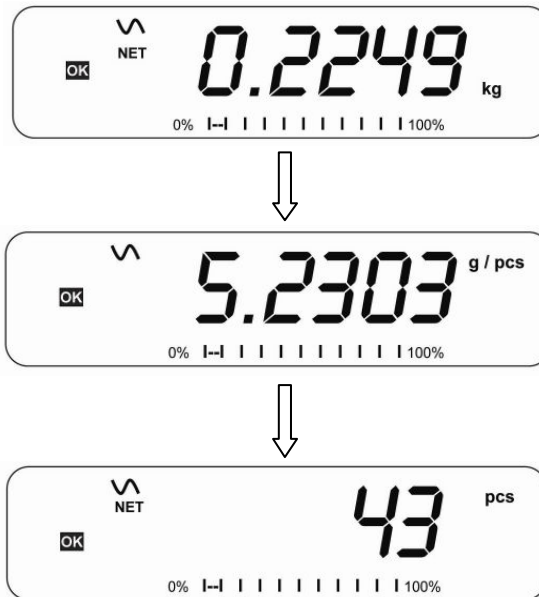

- To count a different sample quantity, press the **[Count]** key. The display will show the last used sample size. Either use this sample size with a different part or enter a new sample size as above.
- To return to weighing, press **[Unit]** when “**0 pcs**” is displayed.

10.5 CHECK-WEIGHING

Check-weighing is a procedure to display an indicator or sound an alarm when the weight on the scale meets or exceeds the values stored in the memory. The memory holds values for a high limit and a low limit. Either or both the limits can be set by the user.

NOTE:

1. The alarm and the LED bargraph can each be set to OFF (See section 13.1). The LCD display will indicate whenever the weight is within or exceeds the limits by showing ‘OK’, ‘HI’ or ‘LO’.

HI	Mass on the balance is above the high limit
OK	Mass is between the limits
LO	Mass is below the low limit

2. The limits can be locked by the manager. A Limit Password must be used to change the limits or recall other limits from memory.

3. If Limit Password is enabled then enter the password which will allow you to change the limits or the operation of the beeper or bargraph.

10.5.1 Setting up check-weighing while weighing

- Press the **[Low Limit]** key. It will show the current low limit. The “LO” symbol will appear on the display.
- Press the **[CE]** key to clear the old value and then enter the new low limit using the numeric keys. The decimal point is fixed at the position that is used for the current weighing unit. When the desired value is shown press **[Tare]** to accept the value. If you want to reset the value to zero, press **[CE]** to clear the value.
- The limits are displayed in the weighing unit in use. If the weighing unit is pounds:ounces, the limits are entered in pounds and decimal parts of pounds. i.e. 6,0125 lb.
- To set the high limit press **[High Limit]**, the display will show the high limit, the “HI” symbol will be on to the left side of the display. Set the high limit in the same way the low limit was set.
- Pressing the **[Tare]** key will return the scale to weighing, with the Check-weighing function enabled.

10.5.2 Setting up check-weighing while parts counting or % weighing

During parts counting and percent weighing the limits are set in the same way as above. The limits are displayed in **pcs** or **%**.

See Section 10.4 for the description of parts counting and Section 10.7 for percent weighing.

NOTE:

1. The weight must be greater than 20 scale divisions for the check-weighing to operate.
2. To disable the check weighing function, enter zero into both the limits as described above. When the current limits are shown, press **[CE]** to clear the settings, enter zero and then press **[Tare]** to store the zero values.

10.6 LIMITS STORING AND RECALLING

The scale can store up to 10 sets of high and low limits in memory along with the weighing units in use (including **pcs** for parts counting and **%** for percent weighing) as well as settings for the beeper and bar graph.

During Check weighing the current limits can be stored or previously stored units can be recalled.

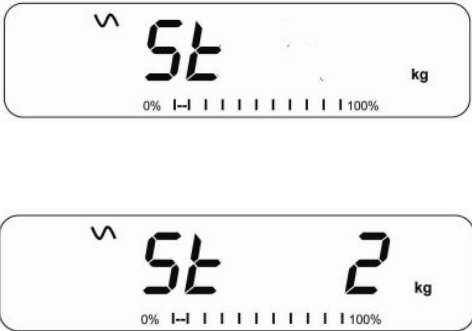
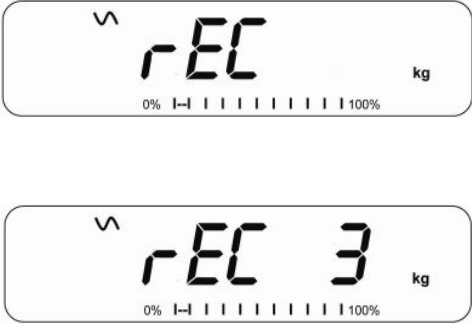
 <p>The first screen shows 'rECALL' with a small 'kg' unit indicator and a bar graph below it. The second screen shows 'StORe' with a small 'kg' unit indicator and a bar graph below it.</p>	<p>Press the [→Lim] key. If you are already in the check weighing mode the display will ask if you wish to store the current limits by showing “StORe” or recall another set of limits by showing “rECALL”. The [→Lim] key can be used to toggle between “StORe” and “rECALL”.</p>
 <p>The first screen shows 'St' with a small 'kg' unit indicator and a bar graph below it. The second screen shows 'St 2' with a small 'kg' unit indicator and a bar graph below it.</p>	<p>If you want to store the limits press [Tare] when “StORe” is displayed. The display shows “St”. Enter a number corresponding to the desired memory location (0 to 9). “St X” will be displayed for 2 seconds indicating the location X where the current limits, weighing units and settings for the beeper and bar graph are stored. The scale will continue to work with the current settings as active.</p>
 <p>The first screen shows 'rEC' with a small 'kg' unit indicator and a bar graph below it. The second screen shows 'rEC 3' with a small 'kg' unit indicator and a bar graph below it.</p>	<p>If you wish to recall any of the pre-stored limits, press [Tare] when “rECALL” is displayed. The display shows “rEC”. Enter the number corresponding to the desired memory location (0 to 9) to be recalled. “rEC X” will be displayed for 2 seconds indicating the values stored in the location “X” is being recalled. The scale will change to the recalled limits, weighing units and settings for the beeper and bar graph.</p>

NOTE:

1. If the recalled limit is for parts counting, the display will show the last sample value used, ready for a new sample to be counted.
2. If the recalled unit is a percent weighing limit, the display will show the last sample value used, ready for a new sample to be weighed.
3. If the memory location was empty the scale will return to weighing.

10.7 PERCENT WEIGHING

The scale can be set to perform percent weighing. See Section 13.1.

The scale will use a mass on the platform as the 100% reference weight. If the platform is empty (or the scale is tared) then the user can input a reference weight using the keypad.

- Press [**Func**]. The first option is “**FUnC 1**”.



- Press the [**Tare**] key. “**F1 Pct**” will be displayed.



- Press [**Tare**] again to enter percent weighing. The scale will set the sample mass on the platform as 100% reference weight.

NOTE: If there is no reference weight on the pan and percent weighing function is entered, pressing [**Tare**] will return the scale will return to weighing.



- Remove the sample weight. Then any other weight placed on the scale will be displayed as a percentage of the original sample. For example,

if 3500g is placed on the scale and percent weighing is selected, the display will show 100.00%. Remove the 3500g weight and place a 3000g weight. The display will show 85.7% as 3000g is 85.7% of 3500g.



- The number of decimal points will depend on the weight used. A smaller weight will show only “100%” while a larger weight might show “100.00%”.
- If the scale was showing zero weight when entering this function, then the user must manually enter the weight to be set as 100%. Press **[Tare]** to accept the reference weight. The display will show “**0.00 %**”.
- If the scale shows “**x x . x x %**”, which is the last weight used as a reference, press **[CE]** to clear and use the numeric keypad to enter a new value. Press **[Tare]** to accept the new reference weight.
- The weight entered must be greater than 50 scale divisions.
- Press **[Unit]** to return to weighing.

NOTE:

The display may jump by large numbers unexpectedly if small weights are used to set as 100% reference. For example, if only 23.5g is placed on a scale with 0.5g increments and is set to 100%, the display will show 100.00%. However a small change of weight will cause the display to jump to 102.13% as an increase of one scale division (0.5g) to 24.0g will be equivalent to an increase of 2.13%.

10.8 ACCUMULATED TOTAL

The scale can be set to accumulate when a weight is added to the scale automatically or manually by pressing **[Print]**. See Section 13.2.

NOTE:

1. The accumulation function is available only during weighing. It is disabled during parts counting or percent weighing.
2. The accumulated weights will be stored in either kg (for g or kg) or lb (for lb, oz or lb:oz).
3. If at any time the weighing units are changed, the accumulated data will be lost.

10.8.1 Manual Accumulation

When the scale is set to manual accumulation, the weight displayed will be stored in the memory when the **[Print]** key is pressed and the weight is stable.

- Remove the weight and press **[Print]** when the scale is at zero. The display will show **"ACC 1"** and then the weight in memory for 2 seconds before returning to normal. The weight can be output to a printer or PC using the RS-232 interface.



- When the scale is at zero place a second weight. Press **[Print]** to accumulate the weight. Remove the weight and press **[Print]**. The display will show **"ACC 2"** for 2 seconds and then show the new total.

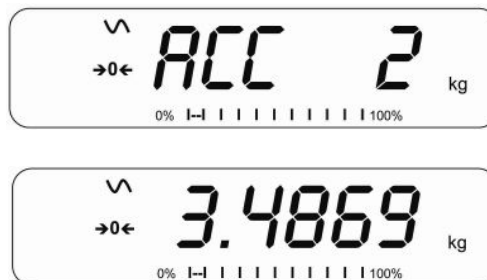

- Continue until all weights have been added. This can continue for up to 99 entries until the capacity of display is exceeded.

- To view the total in memory press the **[Print]** key when the scale is at zero. The display will show the total number of accumulation "**ACC xx**" and the total weight before returning to zero.
- To print the total, press **[Print]** to recall and then immediately press **[Print]** the second time to print the results.
- To erase the memory, press **[Print]** to view the total and then immediately press **[CE]** to clear the memory.

10.8.2 Automatic Accumulation

When the scale has been set to Automatic Accumulation the value is stored in memory automatically.

- Place a weight on the scale. The beeper will sound when the scale is stable indicating the value is accepted. Remove the weight.
- The display will show "**ACC 1**" and then the total in the memory before it returns to zero. Adding a 2nd weight will repeat the process.
- While the weight is on the scale, press the **[Print]** key to view the values- first the accumulation number "**ACC x**" and then the total will be shown.

NOTE:

1. The scale will not show the value when a weight is removed.
2. In all cases the scale must return to zero or a negative number, before another sample can be added to the memory.
3. More products can be added and **[Print]** be pressed again for up to 99 entries until the capacity of display is exceeded.

11.0 RS-232 INTERFACE

The CBK Series are supplied with bi-directional RS-232 interface as standard. The scale when connected to a printer or computer outputs the weight with the selected weighing unit through the RS-232 interface.

Specifications:

RS-232 output of weighing data ASCII code 9600 Baud (user selectable) 8 data bits No Parity

Connector:

9 pin d-sub miniature socket Pin 3 Output Pin 2 Input Pin 5 Signal Ground
--

The scale can be set to print text in English, French, German or Spanish. See the RS-232 parameters section for details.

Data Format-Normal Output:

Only weight value along with the weighing unit is printed. If Percent weighing is used then % is shown in place of weighing units.

Date	12/09/2006	<cr><lf>	
Time	14:56:27	<cr><lf>	
<cr><lf>			
Scale ID	123456	<cr><lf>	If ID is zero, it is left blank
User ID	234567	<cr><lf>	
<cr><lf>			
Net Wt	1.234 Kg	<cr><lf>	Net Wt. (or Gross Wt.)
<cr><lf>			
<cr><lf>			
<cr><lf>			
<cr><lf>			

Data Format-Parts Counting Output:

Weight, Unit weight and number of parts are printed.

```
Date          12/09/2006 <cr><lf>
Time          14:56:27  <cr><lf>
<cr><lf>
Scale ID      123456     <cr><lf>
User ID       234567     <cr><lf>
<cr><lf>
Net Wt.       1.234 Kg   <cr><lf> Net Wt. (or Gross Wt.)
Unit Wt.      123 g     <cr><lf> g for metric and lb for pounds
PCS           10 pcs    <cr><lf>
<cr><lf>
<cr><lf>
```

Data Format- Memory Recall Output:

```
Date          12/09/2006 <cr><lf>
Time          14:56:27  <cr><lf>
<cr><lf>
Scale ID      123456     <cr><lf>
User ID       234567     <cr><lf>
<cr><lf>
-----
<cr><lf>
TOTAL
No.           5          <cr><lf>
Wt.           1.234 Kg   <cr><lf>
PCS           10 pcs    <cr><lf>
<cr><lf>
-----
<cr><lf>
<cr><lf>
```

Data Format- Continuous Output- Normal weighing:

```
Net    1.234 Kg <cr><lf> Net Weight (or Gross wt.)
<cr><lf>
<cr><lf>
```

Data Format- Continuous Output- Parts Counting:

```
Net    1.234 Kg <cr><lf> Net Weight (or Gross wt.)
U.W.   123 g   <cr><lf> Kg and g for metric and Lb for pounds
PCS    10 pcs <cr><lf>
<cr><lf>
<cr><lf>
```

NOTE:

1. The accumulated total will not be sent to the RS-232 when the continuous print is turned on.
2. The continuous print will only be for the current weight and the display data.
3. In other languages the format is the same but the text will be in the language selected.

Description	ENGLISH	FRENCH	GERMAN	SPANISH
Net weight	Net Wt.	Pds Net	Net-Gew	Pso Net
Weight per unit counted	Unit Wt.	Pds unit	Gew/Einh	Pso/Unid
Number of items counted	Pcs	Pcs	Stck.	Piezas
Number of weighing added to subtotals	No.	Nb.	Anzhl	Num.
Total weight and count printed	Total	Total	Gesamt	Total
Print date	Date	Date	Datum	Fecha
Print time	Time	Heure	Zeit	Hora
Scale ID number	Scale ID	Bal ID	Waagen ID	Bal ID
User ID Number	User ID	Util ID	Nutzer ID	Usuario ID

11.1 INPUT COMMANDS FORMAT

The scale can be controlled with the following commands. Press the **[Enter]** key of the PC after each command.

T<cr><lf>	Tares the scale to display the net weight. This is the same as pressing [Tare] .
Z<cr><lf>	Sets the zero point for all subsequent weighing. The display shows zero.
P<cr><lf>	Prints the results to a PC or printer using the RS-232 interface. It also adds the value to the accumulation memory if the accumulation function is not set to automatic.

12.0 CALIBRATION

- The CBK scales are calibrated using kilogram weights and CBKa scales are calibrated using pounds.
- To start the calibration, either get into the calibration section through the Scale Settings (“**FUnC 3**”- see Section 13.3) or turn the scale off and switch on again and then press [**Tare**] during the self-test. Enter code number **0000** and press [**Tare**]. This will take you directly to the calibration section.
- The display will show "**UnLoAd**"
- Remove all weight from the pan and then press the [**Tare**] key when the scale is stable. After the Zero point is set, the display will show "**Ld xx**". Place the suggested calibration mass on the pan. It is best to use a weight close to the full capacity of the scale. If the mass is different from the displayed value, enter the value of the mass in whole numbers. The kg or the lb symbol will be on to show the active unit.
- Press the [**Tare**] key when the stable indicator is on.
- The scale will calibrate to the mass. When complete, it will display "**PASS**" and then either display "**S8 CAL**" (if entered the calibration section through the Scale Settings as per section 13.3) or return to normal weighing (if entered directly). Remove the calibration mass.
- If an error message "**FAIL H**" or "**FAIL L**" is shown, re-check the calibration and repeat. If the error cannot be corrected contact your supplier.

13.0 PARAMETER SETTINGS

Pressing the **[Func]** key allows the user to access the parameters for customising the scale. The parameters are split into 3 groups-

1. Check weighing parameters,
2. RS-232 parameters and
3. Scale parameters

- When **[Func]** is pressed, display will first show “**Func 1**” for Check weighing parameters.
- Enter **[2]** for RS-232 parameters or **[3]** for Scale parameters or press the **[Func]** key to advance through the groups “**Func 1**”, “**Func 2**” and “**Func 3**”. Press **[Tare]** to enter the desired group of parameters.
- Press **[Zero]** to return to the group “**Func 1**”. If you press **[Zero]** again, the scale will exit the User Parameter section and return to normal weighing.

13.1 CHECK WEIGHING PARAMETERS

- Shortcut to enter this group is to press and hold the **[Func]** key for 4 seconds. The display will go directly to “**Func 1**”.
- Press **[Tare]** to enter the group.
- Press **[Func]** to scroll through the parameters and press **[Tare]** to enter a parameter setting.
- Press **[Func]** to view the options for setting.
- Press **[Tare]** to confirm the change and then advance to the next parameter by pressing the **[Func]** key.

This group of parameters-

- enables or disables the percent weighing
- sets the lock for re-setting the check weighing limits
- enables or disables the check weighing LED indicator
- enables or disables the check weighing alarm
- sets the User Password for check weighing
- enables or disables the negative check weighing

Parameter	Description	Options	Default setting
F1 Pct	This parameter allows the user to enter the Percent weighing Function. See Section 10.7.	None	Enabled always
F2 LLK	This parameter prevents the normal user from changing the limits with the help of a Limit Lock.	With LLK set to Off (off), the user is allowed to change limits at any time. With LLK set to Preset (Pst), the user is allowed to use one of the preset limits only.	off
F3 Led	This parameter sets the LED indicator to off or on and the LED type (whether LED's are on in the form of a continuous bar or a spot LED).	bAr - Bar type Spot - Spot type off - Off	bAr
F4 bEP	This parameter sets the Beeper to off or on. If set to on, the beeper can further be set to sound when the weighing result is within or outside the check-weighing limits.	bP off - Off bP inL - Within limits bP otL - Outside limits (>20d)	bP inL
F5 CPS	This parameter allows setting of a new Check weighing password, must be entered twice when asked. When complete, it will display " done ".	To be entered manually.	0000
F6 nCK	This parameter enables negative check weighing function with ability to do negative tare.	on off	on

NOTE:

1. The Check weighing password is separate from the scale password, see section 13.3.
2. If the password is other than 0000, user must enter the password to gain access to "**F2 LLK**", "**F3 Led**", "**F4 bEP**", "**F5 CPS**" and "**F6 nCK**".

13.2 RS-232 PARAMETERS

- Shortcut to enter this group is to press and hold the **[Print]** key for 4 seconds. The display will go directly to “**C1 on**”.
- Press **[Func]** to view the list of parameters.
- Press **[Tare]** to enter a parameter. Press **[Func]** to view the options for the parameter settings.
- Press **[Tare]** to confirm the change and then advance to the next parameter by pressing the **[Func]** key.
- Press **[Zero]** to return to the group “**Func 2**”. If you press **[Zero]** again, the scale will exit the User Parameter section and return to weighing.

This group of parameters can be set by the user for setting the language, baud rate, printing mode, etc. The user can also set a Scale ID number and a User ID number.

Parameter	Description	Options	Default Values or setting
C1 on	Enable or disable the RS-232 interface	Prt on Prt off	Prt on
C2 bd	Baud Rate	600 1200 2400 4800 9600 19200	9600
C3 PrM	Printing Mode- Manual, Continuous or Automatic	mAn , Cont AUto	mAn
C4 Aon	Enable or disable the Accumulation	AC on AC off	AC on
C5 Ln	Select Language	EnGLi (English) FrEnCH (French) GErmAn (German) SPAn (Spanish)	EnGLi
C6 Uld	Set User ID	To be entered manually	000000
C7 Sid	Set Scale ID	To be entered manually	000000

Scale will perform the following, depending on the Accumulation and Print Settings:

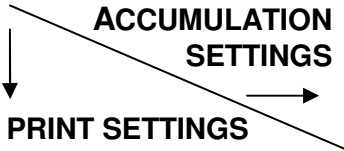
	AC on	AC Off
Auto	Accumulate and print automatically	Print automatically, Do not accumulate
mAn	Accumulate and Print only when [Print] key pressed	Print when [Print] key is pressed, Do not accumulate.
Cont	Print continuously. Accumulate when [Print] key is pressed	Print continuously. Do not accumulate.

13.3 SCALE PARAMETERS

- Shortcut to enter this group is to press and hold the **[Count]** Key for 4 seconds. The display will go directly to “**S1 Un**”.
- Press **[Func]** to view the list of parameters.
- Press **[Tare]** to enter a parameter. Press **[Func]** to view the options for the parameter settings.
- Press **[Tare]** to confirm the change and then advance to the next parameter by pressing the **[Func]** key.
- Press **[Zero]** to return to the group “**FUnC 3**”. If you press **[Zero]** again, the scale will exit the User Parameter section and return to normal weighing.

This group of parameters are used to control the operation of the scale.

Parameter	Description	Options	Default setting
S1 Un	Enable or disable weighing units, will not allow to disable all units, at least one has to be enabled.	kg g lb oz lb:oz	kg

S2 bL	Backlight set to always on, always off or automatic on whenever a weight is placed or a key is pressed	EL off EL on EL AU	EL AU
S3 AoF	Auto Off- Disable or set time increment to turn off scale	SLP 0 SLP 1 SLP 5 SLP 10	SLP 0
S4 dt	Set Time and Date format and settings	Enter the time manually Enter the date manually	00:00:00 mm:dd:yy
S5 diS	Display all weights or only when stable	ALL StAb	ALL
S6 Fi	Filter setting to slow, normal or fast	Slow nor FAST	nor
S7 SPS	Scale Password- If it is anything other than 0000 then the user must enter the password to gain access to any of the scale parameter settings. Must be entered twice when asked. When complete, it will display "done".	PI _ _ _ _	0000
S8 CAL	Calibration	Calibrate the scale. See Section 10.0	-

14.0 ERROR MESSAGES

During the initial power-on testing or during operation, the scale may show an error message. The meaning of the error messages is described below.

If an error message is shown, repeat the step that caused the message. If the error message is still shown then contact your dealer for support.

ERROR CODE	DESCRIPTION	POSSIBLE CAUSES
Err 1	Time input Error	Invalid time entry such as "268970" for the time format " H-m-S ".
Err 2	Date input Error	34 th day of a month is an invalid entry.
Err 4	Initial Zero is greater than allowed (4% of maximum capacity) when power is turned on or when the [Zero/Enter] key is pressed.	Weight on the pan when turning the scale on. Excessive weight on the pan when zeroing the scale. Platform is not installed. Improper calibration of the scale. Damaged load cell. Damaged Electronics.
Err 6	A/D count is not correct when turning the scale on.	Load cell is damaged. Electronics is damaged.
Err 7	Percent input error	Percent function is entered with no reference mass on the pan.
Err 8	High limit input error	Low limit is set first, then the high limit is set lower than the low limit and high limit not equal to zero.
Err 9	Low limit input error	High limit is set first, then the low limit is set higher than the high limit and low limit not equal to zero.
FAIL H or FAIL L	Calibration error	Improper calibration (should be within $\pm 10\%$ of the factory calibration). The old calibration data will be retained until the calibration process is complete.

15.0 REPLACEMENT PARTS AND ACCESSORIES

If you need to order any spare parts and accessories, contact your supplier or Adam Equipment. A partial list of such items is as follows-

- Main Power cord
- Replacement Battery
- Stainless Steel Pan
- In use cover
- Printer, etc.

16.0 SERVICE INFORMATION

This manual covers the details of operation. If you have a problem with the scale that is not directly addressed by this manual then contact your supplier for assistance. In order to provide further assistance, the supplier will need the following information which should be kept ready:

A. Details of your company

- Name of your company:
- Contact person's name:
- Contact telephone, e-mail, fax or any other methods:

B. Details of the unit purchased

(This part of information should always be available for any future correspondence. We suggest you to fill in this form as soon as the unit is received and keep a print-out in your record for ready reference.)

Model name of the scale:	CBK_____
Serial number of the unit:	
Software revision number (Displayed when power is first turned on):	
Date of Purchase:	
Name of the supplier and place:	

C. Brief description of the problem

Include any recent history of the unit. For example:

- Has it been working since it's delivered
- Has it been in contact with water
- Damaged from a fire
- Electrical Storms in the area
- Dropped on the floor, etc.

17.0 WARRANTY INFORMATION

Adam Equipment offers Limited Warranty (Parts and Labour) for the components failed due to defects in materials or workmanship. Warranty starts from the date of delivery.

During the warranty period, should any repairs be necessary, the purchaser must inform its supplier or Adam Equipment Company. The company or its authorised Technician reserves the right to repair or replace the components at any of its workshops depending on the severity of the problems. However, any freight involved in sending the faulty units or parts to the service centre should be borne by the purchaser.

The warranty will cease to operate if the equipment is not returned in the original packaging and with correct documentation for a claim to be processed. All claims are at the sole discretion of Adam Equipment.

This warranty does not cover equipment where defects or poor performance is due to misuse, accidental damage, exposure to radioactive or corrosive materials, negligence, faulty installation, unauthorised modifications or attempted repair or failure to observe the requirements and recommendations as given in this User Manual.

Repairs carried out under the warranty does not extend the warranty period. Components removed during the warranty repairs become the company property.

The statutory right of the purchaser is not affected by this warranty. The terms of this warranty is governed by the UK law. For complete details on Warranty Information, see the terms and conditions of sale available on our web-site.

18.0 APPENDIX

Parameter Layout for CBK Scales (Section 13.0)

Press the [Func] key while in normal weighing to enter this section

Keys (general description of the key functions while in this section):

[Tare] - enter a parameter / accept changed value

[Func] - move to next parameter

[Zero] - return to previous / return to normal weighing (may not save changes)

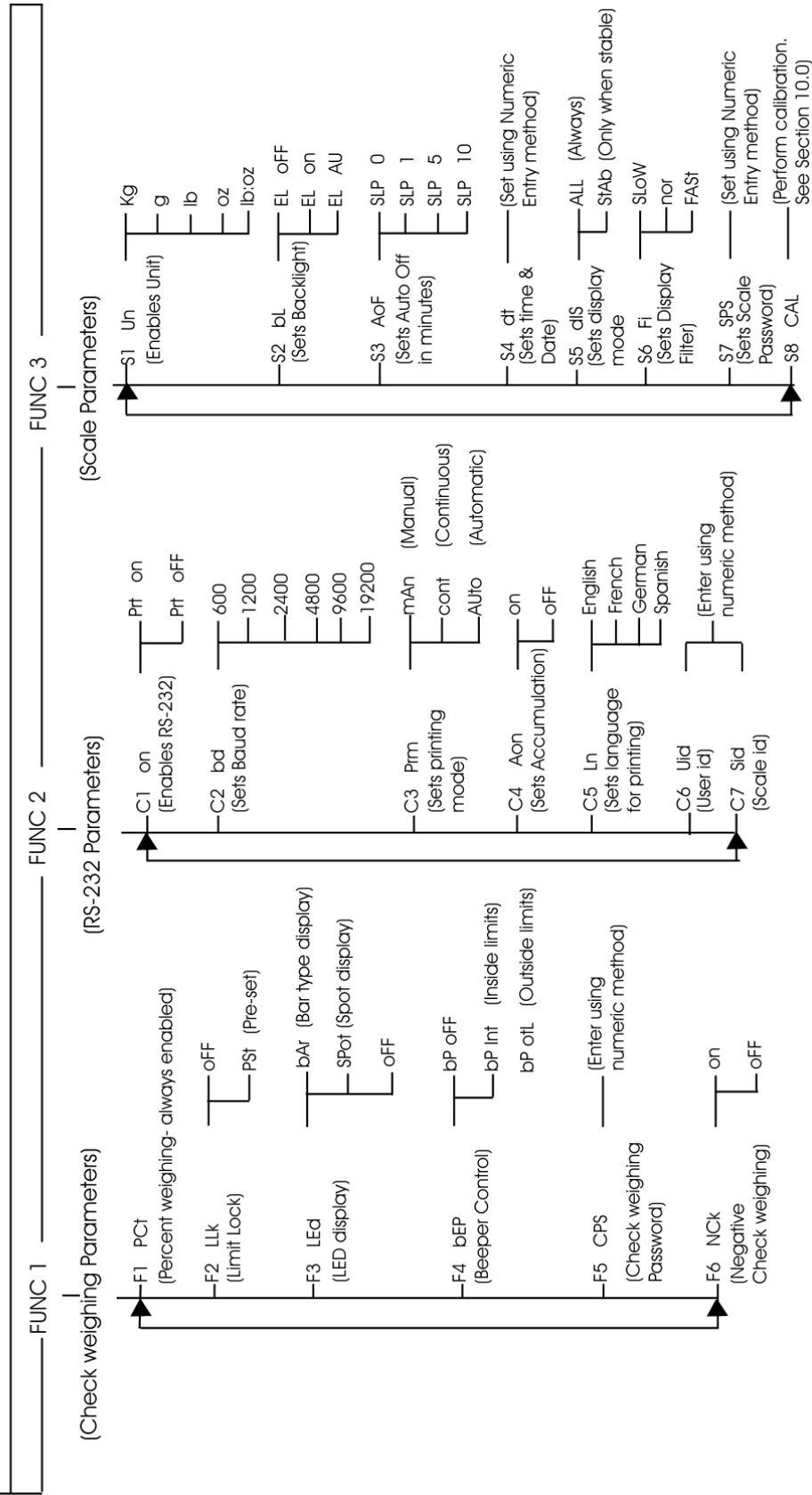



Manufacturer's Declaration of Conformity

This product has been manufactured in accordance with the harmonised European standards, following the provisions of the below stated directives:

Electro Magnetic Compatibility Directive 89/336/EEC

Low Voltage Directive 73/23/EEC

Adam Equipment Co. Ltd.
Maidstone Road, Kingston,
Milton Keynes, MK10 0BD
United Kingdom

FCC COMPLIANCE

This equipment has been tested and found to comply with the limits for a Class A digital device, pursuant to Part 15 of the FCC Rules. These limits are designed to provide reasonable protection against harmful interference when the equipment is operated in a commercial environment. The equipment generates, uses, and can radiate radio frequency energy and, if not installed and used in accordance with the instruction manual, may cause harmful interference to radio communications. Operation of this equipment in a residential area is likely to cause harmful interference in which case the user will be required to correct the interference at his own expense.

Shielded interconnect cables must be employed with this equipment to insure compliance with the pertinent RF emission limits governing this device.

Changes or modifications not expressly approved by Adam Equipment could void the user's authority to operate the equipment.

WEEE COMPLIANCE



Sealed Lead Acid
Battery
Must be recycled
Properly

Any Electrical or Electronic Equipment (EEE) component or assembly of parts intended to be incorporated into EEE devices as defined by European Directive 2002/95/EEC must be recycled or disposed using techniques that do not introduce hazardous substances harmful to our health or the environment as listed in Directive 2002/95/EC or amending legislation. Battery disposal in Landfill Sites is more regulated since July 2002 by regulation 9 of the Landfill (England and Wales) Regulations 2002 and Hazardous Waste Regulations 2005. Battery recycling has become topical and the Waste Electrical and Electronic Equipment (WEEE) Regulations are set to impose targets for recycling.

ADAM EQUIPMENT is an ISO 9001:2000 certified global company with more than 35 years experience in the production and sale of electronic weighing equipment.

Adam products are predominantly designed for the Laboratory, Educational, Medical, retail and Industrial Segments. The product range can be described as follows:

- Analytical and Precision Balances
- Compact and Portable Balances
- High Capacity Balances
- Moisture analysers / balances
- Mechanical Scales
- Counting Scales
- Digital Weighing/Check-weighing Scales
- High performance Platform Scales
- Crane scales
- Medical Scales
- Retail Scales for Price computing

For a complete listing of all Adam products visit our website at
www.adamequipment.com

© Copyright by Adam Equipment Co. Ltd. All rights reserved. No part of this publication may be reprinted or translated in any form or by any means without the prior permission of Adam Equipment.

Adam Equipment reserves the right to make changes to the technology, features, specifications and design of the equipment without notice.

All information contained within this publication is to the best of our knowledge timely, complete and accurate when issued. However, we are not responsible for misinterpretations which may result from the reading of this material.

The latest version of this publication can be found on our Website.

www.adamequipment.com